

Genesis

The Genesis® bow, invented by Mathews Inc. founder and CEO Matt McPherson, combines "zero let-off" with lighter draw weights (10 to 20 lbs*). The result is a bow that fits virtually everyone (draw lengths 15" to 30"*) and that a young person won't outgrow!

Genesis

For the next generation!



Available as a kit!

- Genesis bow
- 5 Easton aluminum arrows
- Arm guard/quiver
- Two targets
- Owner's manual



Genesis® bows are available in flavorful colors!

Mini Genesis

Only 2 pounds!



Mini Genesis

- Scaled down to fit even smaller youngsters
- Draw weights adjustable from 6 to 12 lbs*
- Same revolutionary technology as original Genesis
- Also available in a kit

Genesis Pro



Pro Genesis

- Higher draw weight – adjustable from 15lbs* to 25 lbs*
- Adjustable draw stop (from 18 1/2" to 30")
- Silver, black or red eccentrics – also available in camo
- Larger centershot clearance area

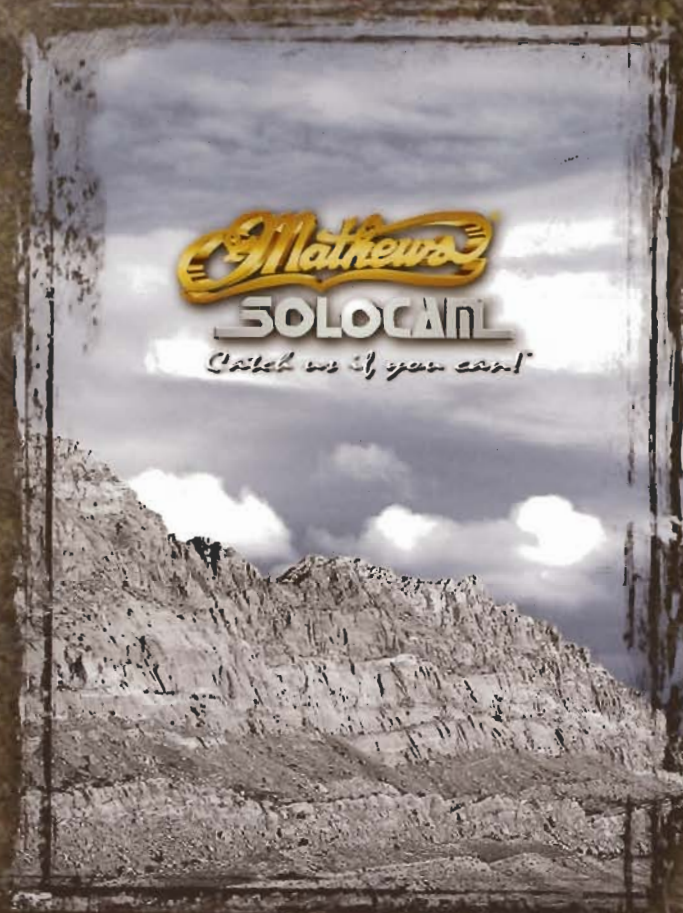

Owner's Manual

2007/2008



NATIONAL ARCHERY
SCHOOLS PROGRAM

Now in 40 states ... over 750,000 students taught nationwide in 2006!

Mathews® is a proud supporter of The National Archery in the Schools Program!

Accessories

ArrowWeb

T-Series Quivers

the next generation quiver for your Mathews SoloCam bow!

Loaded with innovative features including the

Spider Claw quick twist attachment system

T3
Three arrow quiver



T5
Five arrow quiver



T7
Seven arrow quiver



patent pending

Harmonic damper eats up vibration

Foam insert accommodates fixed blade and expandable broadheads

Convertible Arrow rest HDII

with Harmonic Damper

- Converts from drop-away to shoot-through in a flash
- NEW compact, lightweight design
- One wrench size for all adjustments
- Designed specifically for your Mathews SoloCam bow

NEW compact, lightweight design



Congratulations on your purchase of a Mathews bow!

At Mathews, we are committed to making the world's best bows. Single-cam technology, which we introduced in 1992, is the foundation upon which we build every bow. Add technologies like Slim Limbs, Perimeter-Weighted cam, Harmonic Damping and Parallel Limb Design and you have the most innovative and winningest bow built!

Welcome to the Mathews family!

Bow Owner's Personal Record

Please fill the following personal bow record for future reference:

Mathews bow model _____

Bow serial number _____

Retailer purchased from _____

Purchase date _____

Draw length _____" Draw weight _____ #

String length _____" Cable length _____"

Important Notes: _____

Please keep this copy of your bow's serial #, you will need this information should you ever need warranty repair to be done to your Mathews bow.

Safety and warnings...

Warning

You are responsible for archery safety.

Never dry fire your bow

Dry fire means drawing your bow and letting go of the bow string without an arrow attached to the bow string. Without an arrow to absorb the energy from the bow, it may cause the bow to break and there possible could be personal injury along with damage to the bow.

Carefully

Inspect your bow before every shooting session, inspecting the limbs, cable, string and riser. If your bow string/cable are fraying or limbs are splintering, PLEASE contact your local Mathews retailer.

When shooting your bow, be sure of your target and what is beyond and make sure that your back stop is big enough to stop a stray arrow if there happens to be one. As always, make sure that there are no people and buildings in your shooting lane.

Inspect all arrows, inspect for cracked, bent, or dented shafts also inspect nocks and vanes/feathers and replace damaged/loose ones.

Always be safe and abide by all warnings, NEVER aim a bow at another person. NEVER alter your bow. Doing so will VOID any and all warranties and could result in personal injury. Be careful when using broad heads around bow string and cable, nicking or cutting strands of string or cable could cause damage to the bow or personal injury. When working on your bow in a bow press, wear safety glasses and before pulling bow back for first time after bow has been in a bow press make sure that the string and cable are in their proper tracks on the cam and idler wheel.

If you draw the bow with an arrow in it and decide not to shoot you'll have to let the bow down, keep your bow arm straight and prepare for a rapid let down of the bows string. Keep your head and face back on out of danger during a let down. NEVER try pulling a bow that has more poundage that you are comfortable pulling.

Your local authorized Mathews retailer is your best source for information and assistance. Visit them for these and other typical services:

1. Adjusting draw length and draw weight
2. Adjusting/changing let-off
3. Replacing/servicing strings and cables
4. All aspects of bow tuning
5. Correct arrow selection
6. Mounting new accessories

Setting up your new Mathews bow...

As you probably know, once your Mathews bow is properly tuned, it will stay in tune thanks to the single-cam design. However, initial setup of draw length, weight, nock point, etc. is critical to maximize the performance of your new bow.

Draw Length

The majority of Mathews bows are engineered to be draw length specific and offer no draw length adjustment on the cam. Your shooting style should be measured to ensure a proper fit, resulting in maximum performance from your Mathews bow. Draw length is measured by the distance from knock point to the rest hole plus 1 3/4". If you intend to shoot with a release, make sure you measure draw length with your release on.

Draw length may be shortened by 1" on the following models: Conquest 4, Conquest 3, Classic, FX2. This is accomplished by moving the end loop of the string to any of three adjustment posts on either side of the cam. For example: on a 29" cam, the 1-1 post would be 29", the 1-2 post would be 28 3/4", the 2-2 would be 28 1/2", 2-3 would be 28 1/4" and 3-3 would be 28". A Mini Max cam can be adjusted down from its maximum draw length approximately 1/2" by moving the string loop to the secondary post on the cam.

Draw Weight

Mathews SoloCam bows have a 10 pound weight reduction range from your bow's peak weight (example: if your bow has a peak weight of 70 pounds, you can adjust it as low as 60 pounds). Draw weight adjustments are made using either a 3/16" or 7/32" Allen wrench. Turn the limb bolt clockwise to increase the draw weight and counter-clockwise to decrease the weight. Each rotation is equivalent to 2 to 4 pounds of draw weight. It is very important to adjust the limb bolts equally but do not exceed 5 full turns out from maximum draw weight.

Nock Point Installation

There are many variables involved in determining where to install your nock point. These include: type of arrow rest, arrow spine, whether you use fingers or a release aid, and your hand placement on the bow. As a general rule, the nock point should be set perpendicular (90°) to your arrow rest or somewhere within 1/2" above the 90° point. This guideline is a starting point – you may need to move your nocking point as you fine-tune your Mathews SoloCam bow.

Bow press...

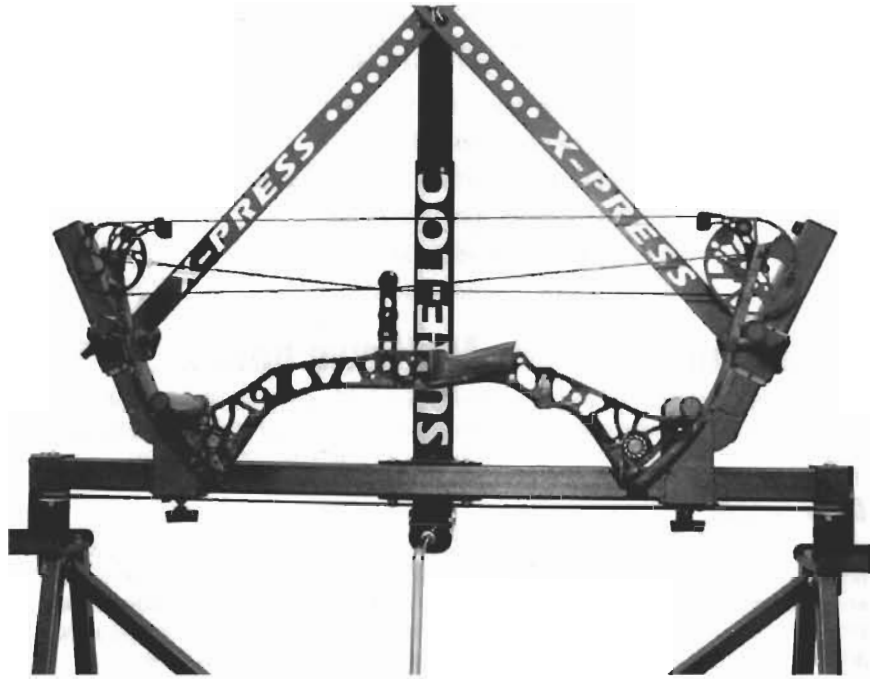

Presses the bow in two places

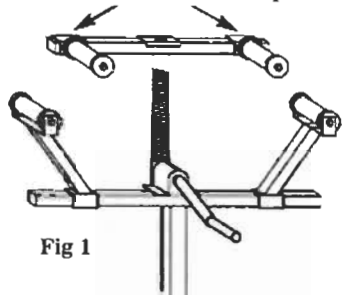

Fig 1

Fig 1: (An example of a double pull bow press)

Always use a double bow press like that shown in figure 1 when working on your bow. **Never use a single pull bow press.** (See fig 2)

Presses the bow at the grip only

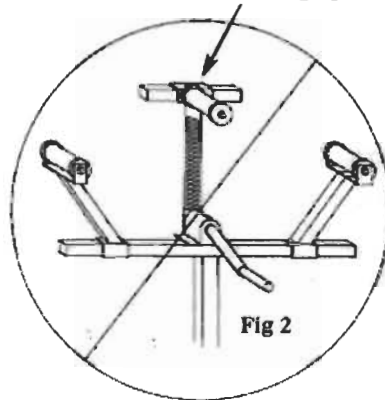
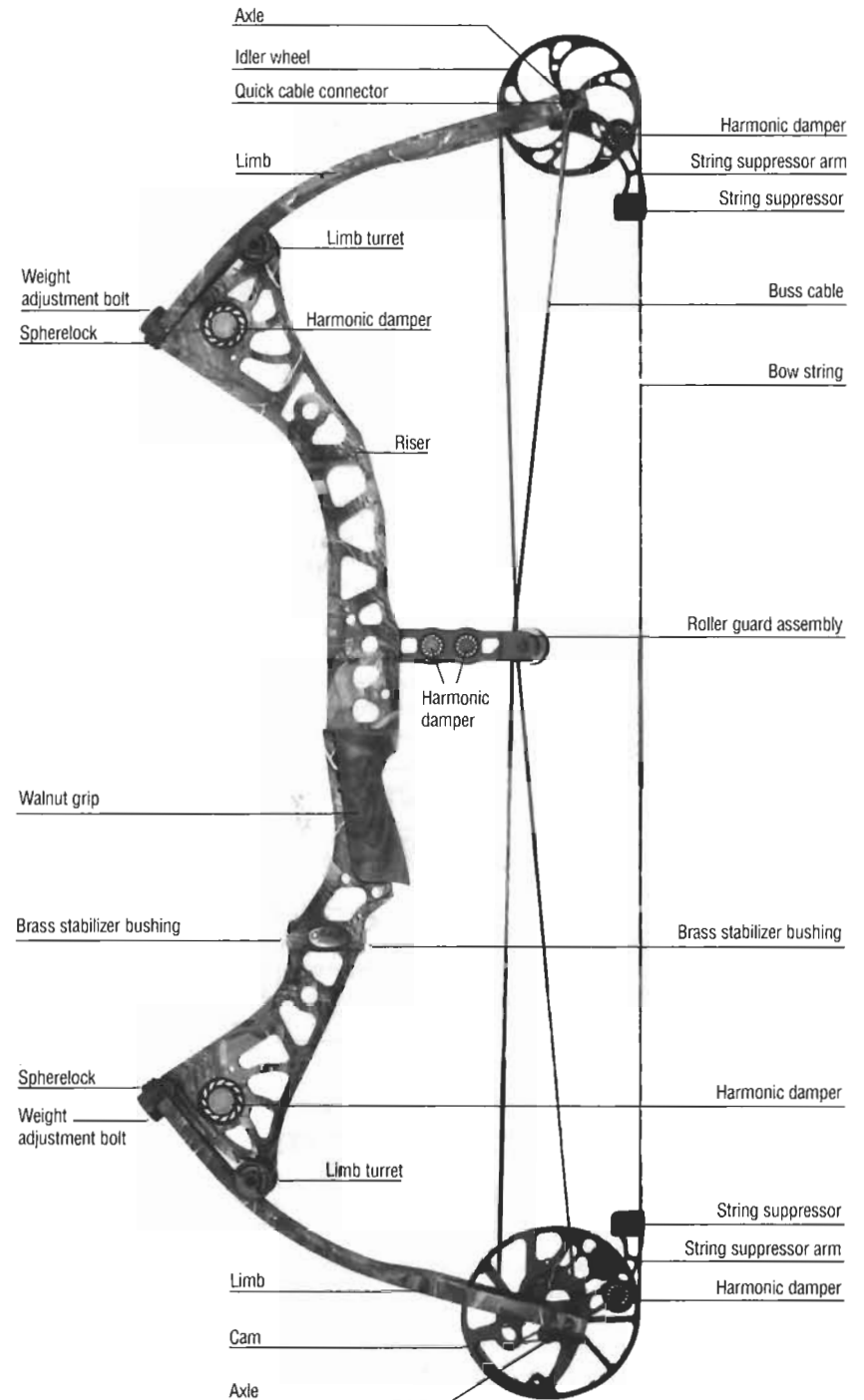

Fig 2

Fig 2: (An example of a single pull bow press)



Tuning your Mathews® SoloCam® bow...

Tiller

Setting the tiller on your Mathews SoloCam bow is easy. In fact, there's no measuring necessary. Starting from a point where both limbs are tightened completely, simply back them off an equal number of turns.

Estimating Center Shot



Using the correct arrow size, position your arrow on the string at the nock point. We recommend 13/16" over from the riser to center of arrow shaft. This is a good reference point to begin paper tuning.

The Importance of Paper Tuning and Tear Patterns

With an improperly tuned bow, broadheads may shoot as much as 18" off center at 20 yards (when compared to field tips). By tuning a bow to shoot a good hole in paper, you will ensure the best possible broadhead flight.

Before beginning, it's important to know that perfect "bullet holes" are not always possible with all shooters. Light tears are quite acceptable and will not deter accuracy. Fine tuning requires patience and consistent shooting form. Perfect results are only achieved with perfect form. Also, remember to always do your final sightings with broadheads before hunting.

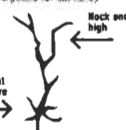
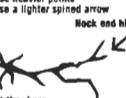
To begin paper tuning, stand approximately eight feet from the paper (with a suitable backstop several feet behind the paper to allow complete arrow passage). Check your tear pattern against the following boxes for further instruction. If it's a combination, such as up and to the left, both instructions will apply.

<p>After the shot, push the paper back flat and you will see a star shaped entry hole where the tip went through.</p>  <p>SOLUTION: Nock End Ripped Low</p> <ol style="list-style-type: none"> 1. Raise the nocking point 2. Use a heavier arrow tip 3. Use a more limber spined arrow <p>Note: (same for left hand)</p>	<p>SOLUTION: Nock End Ripped High</p> <ol style="list-style-type: none"> 1. Lower the nocking point 2. Use a lighter arrow tip 3. Use a more stiffer spined arrow <p>Note: (same for left hand)</p>  <p>NOTE: If lowering nocking point does not eliminate problem try a different kind of arrow rest.</p>	<p>Nock End Ripped Right Arrow Spine Too Stiff</p> <p>Alternatives:</p> <ol style="list-style-type: none"> 1. Increase draw weight 2. Move arrow rest to the left 3. Use heavier points 4. Use a lighter spined arrow  <p>5. Use longer arrows if possible</p> <p>(Opposite for left hand)</p> <p>Note: Feathers or vanes may be hitting arrow rest. Try a different arrow rest. (left hand only)</p>	<p>Nock End Ripped Left Arrow Spine Too Limber</p> <p>Alternatives:</p> <ol style="list-style-type: none"> 1. Decrease draw weight 2. Move arrow rest to the right 3. Use lighter points 4. Use a stiffer spined arrow  <p>5. Use shorter arrows if possible</p> <p>6. Vanes or feathers may be striking arrow rest. Try a different arrow rest.</p> <p>Note: (Opposite for left hand)</p>
---	--	--	---



This is an example of a properly tuned bow. Note that the point where the arrow tip went through is centered in the middle of three very comparable vane tears.

Broadhead tuning

Most archers discover that they must make slight tuning adjustments when switching from practice points to broadheads (even at same weight). Broadheads have different aerodynamics than field points and this will change arrow flight and for this reason some adjustments may be needed in the rest height or nocking point and maybe your sight. Always test your broadhead flight before you go hunting to make sure of your arrow flight, even expandable heads need to be test fired.

Arrow selection...

Determining Proper Arrow Length

The first step in selecting your arrows is to determine your arrow length. If you are using an overdraw, you can mark the arrow just in front of the rest. The distance from your mark to the string groove in the arrow nock will be your correct arrow length. Your Mathews retailer can be an invaluable help in this process.

Maintaining your Mathews® SoloCam® bow...

Periodically check strings and cables

Always inspect your bow for frayed strings and cables. Replace damaged strings and cables immediately. The Zebra ZS Twist bowstrings on your Mathews bow should be waxed and maintained as any other fast-flight string. If you change bowstrings, please make sure you are using the proper length string for your bow.

Bushings are self-lubricating

Your Mathews SoloCam bow requires no lubrication - all bushings are self-lubricating or have sealed ball bearings.

Storing your bow

Avoid storing your bow for extended periods in areas subject to extreme heat such as the trunk of a vehicle or in a garage. Extreme heat may cause damage to limbs, strings, and other bow parts and is not covered under the manufacturer's lifetime warranty.

If your bow is subjected to moisture, be sure to completely dry it before storing for extended periods in a bow case.

Warranty on your Mathews® SoloCam® bow...

Repairs and shipment

Visit your Mathews retailer for servicing and repairs. All bows and warranty parts returned to the factory will require a Return Authorization (RA) number that your retailer can obtain. Your retailer will handle all warranty issues for you. The RA number must be clearly printed on the outside of the box near the address label. If a package does not have an RA number, our shipping department will refuse delivery.

LIMITATION OF LIABILITY

MATHEWS MANUFACTURING, INC. SHALL NOT BE LIABLE FOR ANY SPECIAL OR CONSEQUENTIAL DAMAGES THAT RESULT FROM THE PERFORMANCE AND USE OF THE PRODUCTS, EVEN IF MATHEWS MANUFACTURING, INC. HAS BEEN ADVISED OF THE POSSIBILITY OF SUCH DAMAGES. APPLICABLE LAW MAY NOT ALLOW THE LIMITATION OF EXCLUSION OF LIABILITY OR INCIDENTAL OR CONSEQUENTIAL DAMAGES, SO THE ABOVE LIMITATION OR EXCLUSION MAY NOT APPLY TO YOU.

Continued on page 10

Warranty information

Every Mathews SoloCum bow has a LIMITED LIFETIME WARRANTY. Warranty repairs are our top priority. Each bow has a unique serial number, which your Mathews retailer will register with Mathews Inc. at the time of purchase. Should you ever need repairs, the Mathews retailer from whom you purchased your bow is very knowledgeable about the bows and may be able to complete the work right in their store. If the bow does need to be sent to us, we assure you that we do strive to do the warranty repairs and service work and re-ship your bow within three working days from the time it arrives in our shop.

LIMITED LIFETIME WARRANTY

THIS BOW IS WARRANTED AGAINST DEFECTS IN MATERIALS AND WORKMANSHIP TO THE ORIGINAL OWNER WHEN PURCHASED AT AN AUTHORIZED RETAILER, FOR THE LIFE OF THE ORIGINAL OWNER. THIS INCLUDES ALL BOW PARTS EXCEPT THE STRING, BUSS CABLE, CABLE SLIDE, RUBBER STRING SUPPRESSOR "FINGER" AND COSMETIC APPEARANCE (CHIPS, DINGS, SCRATCHES) CAUSED BY NORMAL USE AND WEAR. BOWS SENT BACK TO MATHIEWS WITHOUT A PRE-ISSUED RETURN AUTHORIZATION NUMBER WILL BE REFUSED. ANY AND ALL WARRANTIES, WRITTEN OR IMPLIED, ARE VOID WITH ANY ALTERATIONS TO THE BOW.

Honesty is the best policy...

Mathews bows are covered by one or more of the following patents, with other patents pending:
#5,368,006, #5,676,123, #5,752,496, #5,791,322, #5,809,982, #5,890,480, #5,996,567

Frequently Asked Questions (with answers from the technical staff at Mathews)

Q: Can I get a Zebra Barracuda string for my older Mathews bow?

A: Yes. Zebra Barracuda bowstrings are available all of our different models.

Q: Is the let-off on a Mathews bow adjustable?

A: The let-off on your Mathews bow, or more accurately, the cam, is specific to that cam. To change the let-off you would need to order a cam with the let-off that you want to change to.

Q: Where do I start my nocking point when setting up my new Mathews bow?

A: As a starting point, place your nock point level to 1/8" high of center.

Q: What weight arrow should I use for IBO and AMO speed tests on my bow?

A: We test IBO speeds with bows at 70-pound draw weight and at 30" draw length with an arrow that weighs 350 grains. The AMO test is done with a bow at 60-pound draw weight and 30" draw length with an arrow that weighs 540 grains. Nothing added to the bowstring.

Q: How do I get center shot on my Mathews bow? Do I use a center-shot tool?

A: We recommend measuring off the side of the riser at the rest attachment hole to the center of the arrow shaft approximately 13/16". Adjust the rest as needed for proper arrow flight. A center-shot tool is not needed.

Q: What is the minimum arrow weight I can safely shoot with my Mathews bow and still not void the lifetime warranty?

A: Five grains per pound of draw weight would be the minimum.

Q: Do the string suppressors weaken the limbs?

A: On the contrary, the string suppressors actually strengthen the limbs.

Q: Can I take the String Suppressor arms off and still shoot my bow?

A: No, this would not be a safe thing to do. To incorporate the suppressor arms the limbs must be drilled, the arms put on and the screws installed. Removal could weaken the limbs and could possibly cause damage to the bow and/or personal injury.

Q: Can the Harmonic Damper weights be interchanged?

A: Yes, they can be arranged for a custom fit and feel.

Q: What type of bow press should I use with my Mathews bow?

A: A dual-roller bow press works best. Stay away from center pull bow presses. They could damage your riser.

Q: Can I order parts directly from Mathews?

A: Any part, under warranty or otherwise, should be ordered directly through any of our authorized Mathews retailers. They can get parts to repair your bow and, if necessary, can send the bow to the factory for repairs. The Mathews retailer must initiate all repairs.

Q: Why doesn't Mathews have a split-limb bow?

A: Some manufacturers introduced split-limb designs to reduce bow weight. Our bows are already among the lightest on the market. In fact, when you compare the width and weight of our SlimLine limbs to many of the split-limbs (the combination of both limb halves), our limbs are narrower and lighter! Also, through testing, we've determined that split-limbs are inferior, because they often have an unbalanced load. If you place a straight-edge across the limb halves, you'll often find they aren't even with each other. They may have cosmetic appeal, but we have yet to find any shooting benefits.

Q: I want to introduce my children to archery. What should I do?

A: Consider the Genesis bow. It's a bow that fits virtually everyone. Its zero let-off design means there are no specific draw lengths. Anybody with a draw between 15" and 30" can shoot the bow. So, as kids grow, they won't outgrow this bow! And, at 20 pounds, the Genesis will shoot an arrow with the speed of a 35-pound recurve!

For even younger children, there is also the Mini Genesis. It's approximately six inches shorter than the Genesis, features draw weights that adjust from 6 to 12 lbs. and weighs just 2 lbs.!

For older kids, look at the Genesis Pro, a version of the Genesis that offers higher draw stop.

Finally, you can now get your child a Mathews bow. The Mathews Ignition is smooth shooting youth bow. The Ignition is available with peak draw weights from 20 to 50 lbs. and sports a generous brace height of 6 1/2 inches making it an extremely forgiving bow to shoot. Plus, we offer on affordable cam exchange program through our retailers.

The Mathews Heritage Bows...

Elegant works of art and craftsmanship that offer exceptional performance!

Designed by Matt McPherson; inspired by childhood memories of his father and archery.

See the Heritage at your Mathews retailer!

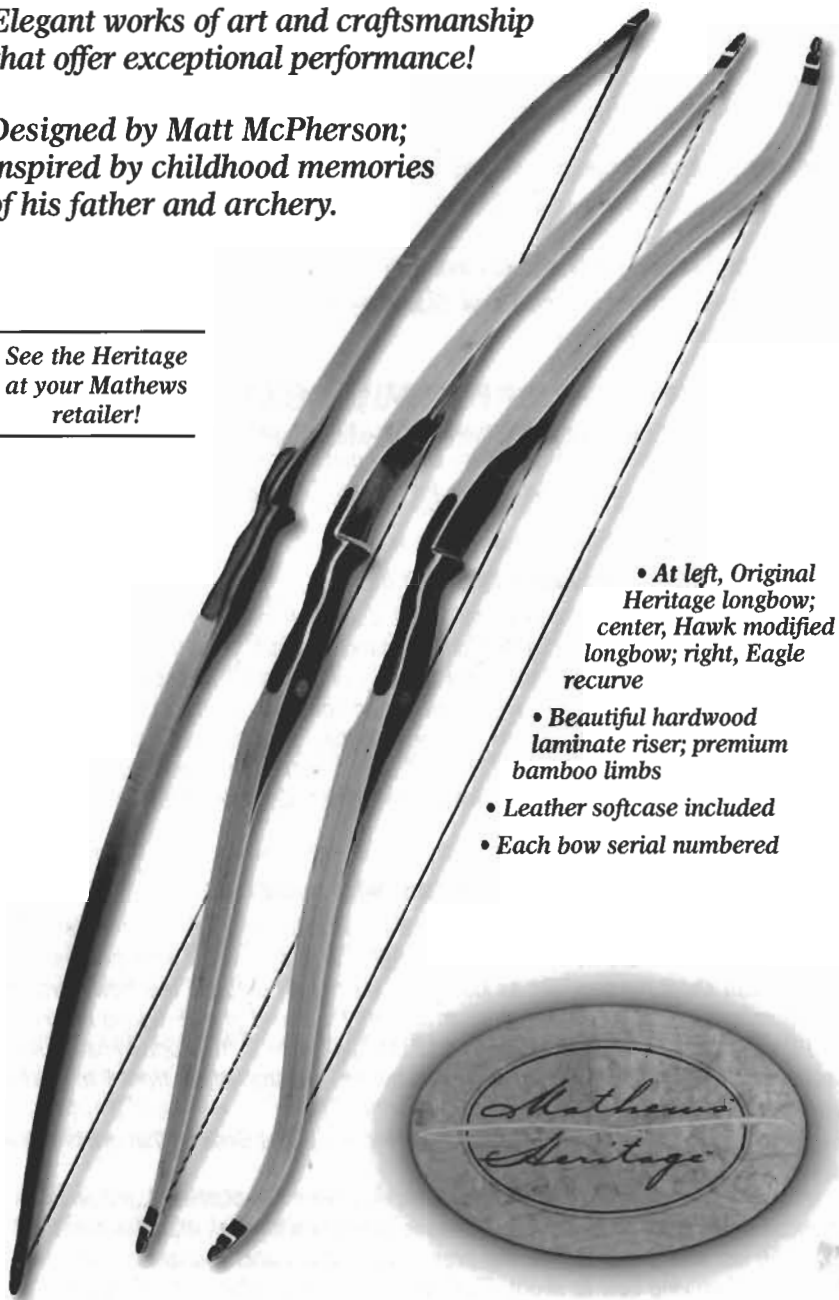

- At left, Original Heritage longbow; center, Hawk modified longbow; right, Eagle recurve
- Beautiful hardwood laminate riser; premium bamboo limbs
- Leather softcase included
- Each bow serial numbered

Justin Charles **Outdoor Gear**

Justin Charles Thermal Underwear

Made of 100% Super-Fine Merino Wool

- Extremely soft; won't itch or irritate your skin
- Wicks moisture 28%* faster than synthetics
- Absorbs 30%* of its weight before feeling damp (vs. 5%* with synthetics)
- Wool neutralizes bacteria growth so it won't smell
- Natural fiber crimps create air pockets for better insulation
- Naturally stretchy for a comfortable fit
- Fully machine washable

*Approximately



See it at your Mathews retailer! or visit www.justincharles.com

**The best performing
bowstrings in the world!**



**Zebra[®]
Barracuda[®]
Bowstring**

The best performing string in the world!
Proprietary manufacturing
process results in a bowstring
that offers maximum
performance

**Incredibly stable
anti-stretch technology**



Made from a
precision blend
of high-strength
materials

**Zebra[®] ZS Twist[®] bowstrings features
patented ZS Twist[®] technology that
minimizes peep rotation**

**Zebra[®] strings win over
\$4,750,000**

in the last 7 years
Shoot what the winners shoot!



Wear what the pros wear!

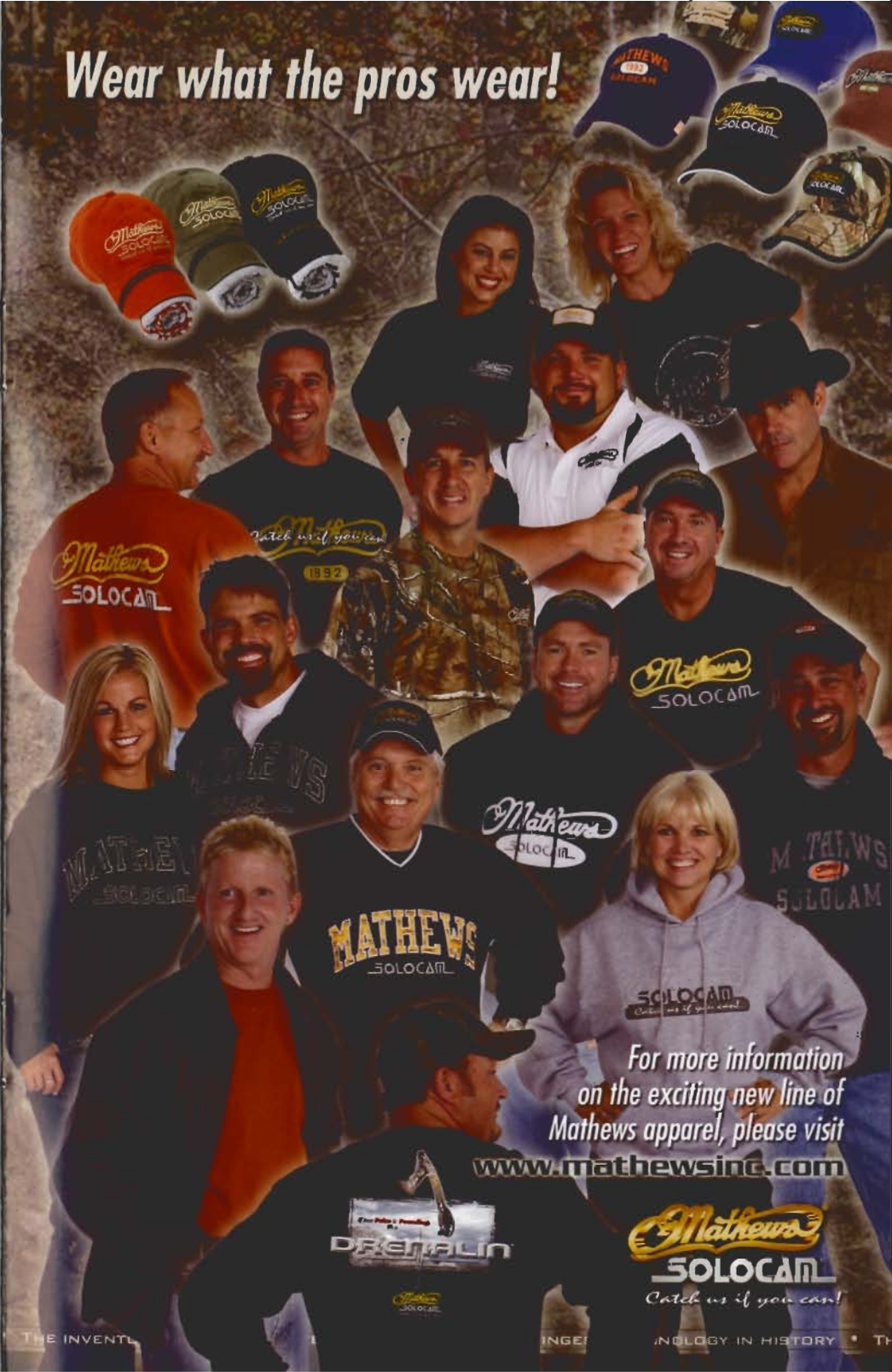

For more information
on the exciting new line of
Mathews apparel, please visit
www.mathewsinc.com

**Mathews[®]
SOLOCAM**
Catch us if you can!